

# AIM-89H

## 13.3" Medical-Grade Tablet with Intel® Core™ i5 processor



### Features

- 13.3" Full-HD IPS projected capacitive 10-point multi-touchscreen with anti-fingerprint, anti-glare Corning® Gorilla® Glass
- Intel® Core™ i5 processor support on Windows 10/11 IoT Enterprise for high performance
- EN/UL 60601 certification, ensuring patient and medical staff safety by protecting against excessive heat and electronic interference
- Equipped with DeviceOn - iService Suite software for remote device management
- Supports touch mode with gloved operation and an active stylus pen
- IP65-rated protection from water and dust ingress
- MIL-STD-810G Shock/Vibration compliance with 4-ft drop tolerance
- Built-in Wi-Fi 6, Bluetooth 5.2, and Gigabit LAN for high speed connectivity
- 16-pin pogo connector for Desk Docking Stations and VESA Mount Bracket
- Antimicrobial design with IONPURE® on the rear cover, allowing for repeated cleaning with disinfectant



### Introduction

AIM-89H tablet is a slim, rugged, multi-functional, Intel-powered 11th Core™ i5 processor high performance tablet for medical and commercial uses. The IP65 water/dustproof 13.3" IPS Full HD screen with capacitive 10-point multi-touchscreen, anti-fingerprint (AF), anti-glare (AG), Gorilla Glass, could support touch mode under glove, rain, water puddle. Built-in Wifi 6, bluetooth 5.2 and gigabit LAN supports fast, steady connectivity. Internal front (5M) and rear (8M) camera provide picture capturing wherever. MIL-STD-810G shock/vibration compliant tested on our rugged design with 4ft (1.2m) drop tolerance. ITE/Medical grade dual certification are ready for indoor and healthcare environment.

Moreover, AIM-89H is equipped with Advantech's DeviceOn - iService Suite software, which is a next-generation unified device management solution based on the WISE-DeviceOn platform. With support for batch operations and multi-device control, DeviceOn - iService Suite enables easy device configuration and deployment for convenient remote device management.

### Specifications

System	Processor	Intel® Core™ i5-1145G7E Processor quad-core, 1.5 GHz (8M Cache, up to 4.10 GHz)	
	Memory	8GB DDR4	
	OS	Windows 10/11 IoT Enterprise (Linux OS optional)	
Storage	SSD	256 GB (m.2)	
	Type	13.3" IPS LCD	
Display	Resolution	FHD 1920x1080	
	Brightness	400 cd/m <sup>2</sup>	
	Touch Type	10-point multi-touch P-CAP touch control	
	Glass Type	Corning® Gorilla® Glass 3 (Anti-Fingerprint, Anti-Glare)	
	Touch mode	Normal (support under water puddle), Glove	
	Communication	WLAN	IEEE 802.11 a/b/g/n/ac/ax (Wi-Fi 6)
Connectivity	Bluetooth	Bluetooth® v5.2	
	Standard I/O	1 x Gigabit LAN, 1 x HDMI, 2 x USB-A 3.1 Gen 2, 1 x Audio Jack, 1 x 19 VDC-in jack, 1 x USB-C 3.1 Gen 2 (10Gb/s, HDMI Alt, 5V, 2A, Charging via AIM-89H Adaptor with DC to Type-C Dongle Accessories)	
	Docking	1 x AIM docking 16-pin pogo connector: 1 x USB 3.1 Gen 2	
Audio	Audio Jack	1 x Audio combo jack (combines stereo audio output and mono microphone input)	
	Speaker	2 x Internal water proof speakers (2 W)	
Camera	Front	5.0-megapixel fixed-focus camera	
	Rear	8.0-megapixel auto-focus camera with LED flash	
Sensors		Ambient Light Sensor, G-sensor, Gyroscope	
Control Buttons		1 x Power button, 2 x Volume key (up/down), 3 x Programmable button	
System Indicator		Full: green (90-100%); Charging: blue; Low: red (<10%)	
Power System	Input Voltage	DC jack: 19V/4.74A (90W)	
	Battery	Embedded Lithium-ion battery; 10.8V, 4660 mAh, 50.32 WHr Operating time: Up to 4.5 hours (depending on usage scenario) Charging time: < 3 hours	
Environment	Operating Temperature	0 ~ 40 °C (32 ~ 104 °F) Discharging: 0 ~ 40 °C (32 ~ 104 °F) Charging: 0 ~ 35 °C (32 ~ 95 °F)	
	Storage Temperature	-20 ~ 60 °C (-4 ~ 140 °F)	
	IP Rating	IP65	
	Shock	MIL-STD-810G standard	
	Vibration	MIL-STD-810G standard	
	Drop Tested	MIL-STD-810G standard, Up to 122 cm (4 ft) onto plywood over concrete	
	Humidity	Operating: 90% @ 40 °C non-condensing Storage: 95% @ 45 °C non-condensing Package: 95% @ 60 °C non-condensing	
Characteristics	Dimension (W x D x H)	330 x 240 x 20.8 mm (13 x 9.4 x 0.8 in)	
	Weight	1.8 kg (3.97 lb)	
	Color	White/Blue	
Certifications		FCC, CE, UKCA, IEC/EN/UL60601-1, EN 60601-1-2, WEEE	

**Dimensions**

Unit: mm

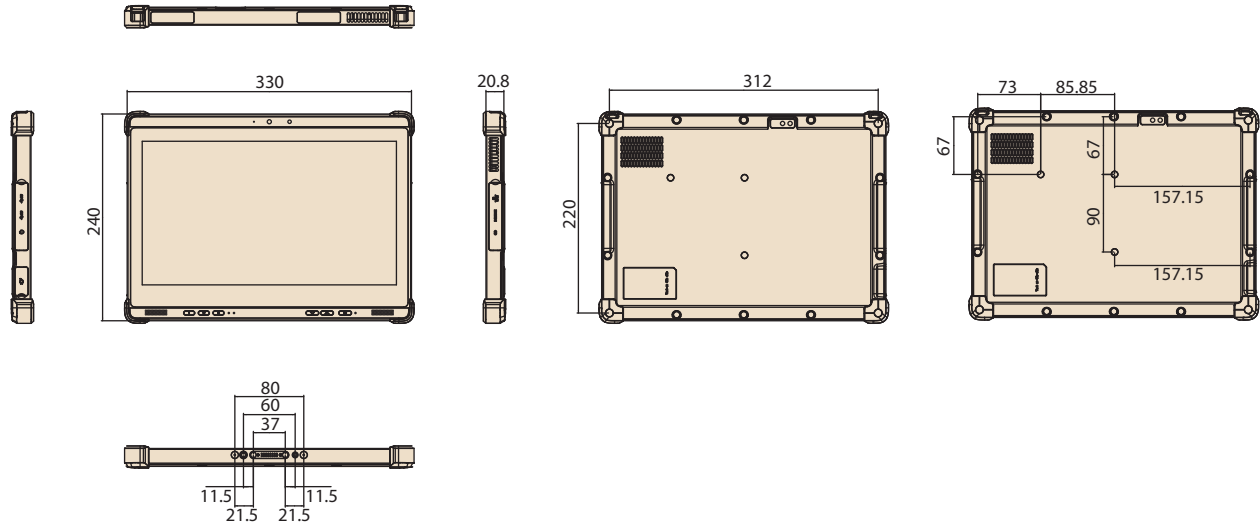

**Front/Rear/Side I/O View**

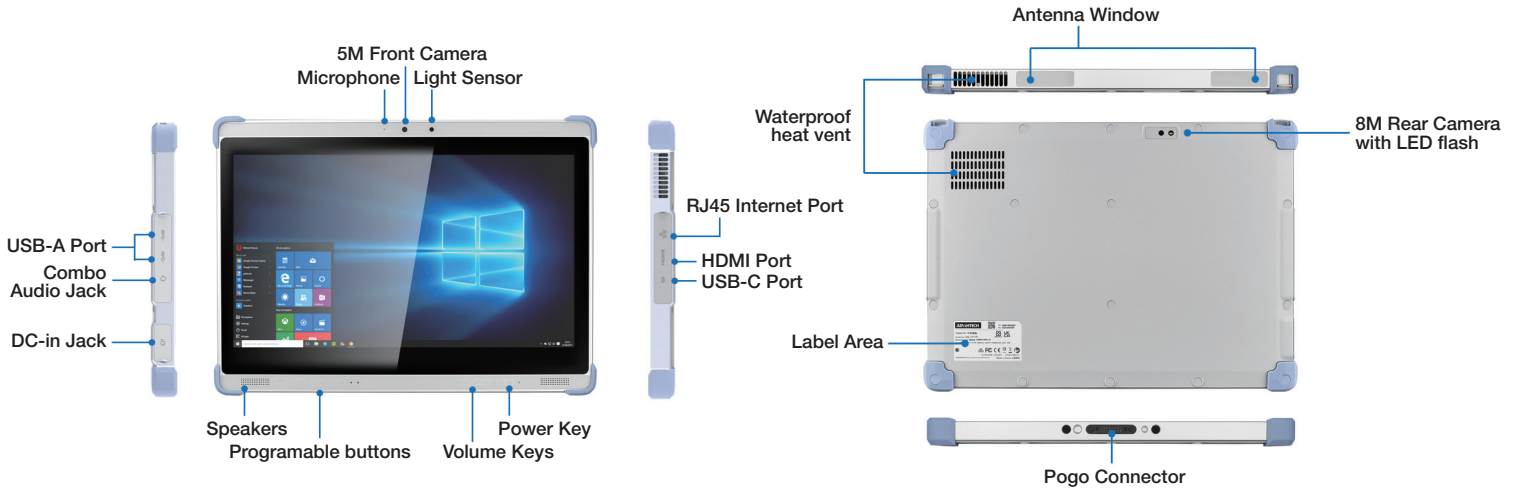

**Ordering Information**

Part Number	CPU	Memory	Storage	Front/Rear Camera	Corner	OS
AIM-89H-100110	Core-i5-1145G7E	8GB	256GB	V	Blue	Windows 10 LTSC 21H2
AIM-89H-111110	Core-i5-1145G7E	16GB	512GB	V	Blue	Windows 10 LTSC 21H2
AIM-89H-100210	Core-i5-1145G7E	8GB	256GB	V	Blue	Windows 11 GAC 22H2
AIM-89H-111210	Core-i5-1145G7E	16GB	512GB	V	Blue	Windows 11 GAC 22H2
AIM-89H-100310	Core-i5-1145G7E	8GB	256GB	V	Blue	Without OS
AIM-89H-111310	Core-i5-1145G7E	16GB	512GB	V	Blue	Without OS

**Optional Accessories**

Part Number	Description
1700001524	Power cord (USA) UL 3P 10A 125V 183 cm
1700008921-11	Power cord (Japan) PSE 3P 7A 125V 183 cm
170203180A	Power cord (UK) BSI 3P 2.5A 250V 183cm
170203183C	Power cord (EU) 3P 2.5A 250V 183 cm

**Packing List**

Description
1 x AIM-89H tablet
1 x AC/DC adaptor

# AIM-89H Desk Docking Station



## Features

- Suitable design for office applications
- Reliable docking connector with LED indicator for connectivity
- Equipped with a variety of I/O for easy integration
- HDMI 1.3 and DP 1.1 for user quick set up extended screen
- Additional USB 3.0 ports extend peripherals like keyboard/mouse/data collection device

## Specifications

		Desk Docking Station
I/O		1 x HDMI 1.3 1 x Display Port 1.1 1 x Gigabit Ethernet (RJ45) 2 x USB 3.0 Type A 1 x 5.5 mm DC in port
	Power	Input Voltage/Power 19V, 4.74A, 90W AC-adaptor
Mechanical	Dimensions (W x D x H)	162 mm x 180 mm x 133 mm
	Weight	1360 g / 2.99 lb
Environment	Operating Temperature	0°C - 40°C (32°F - 104°F)
	Storage Temperature	-20°C - 60°C (-4°F - 140°F)
	Relative humidity	Operating: 10% to 80% (non-condensing) Storage: 5% to 90% (non condensing)
	Certifications	FCC, CE, UKCA, IEC/EN/UL60601-1

## Dimensions

Unit: mm

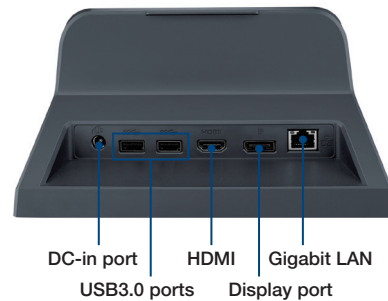

## Ordering Information

Part Number	Description
AIM-OFD0-0005	AIM-89H Desk Docking Station with full I/O

## Packing List

Description
1 x AIM-OFD0-0005

Note: The above product does not include adapter and power cable. Customers must order AIM-89H first and pair with specific country power cable for usage.

# AIM-89H VESA Mount Bracket

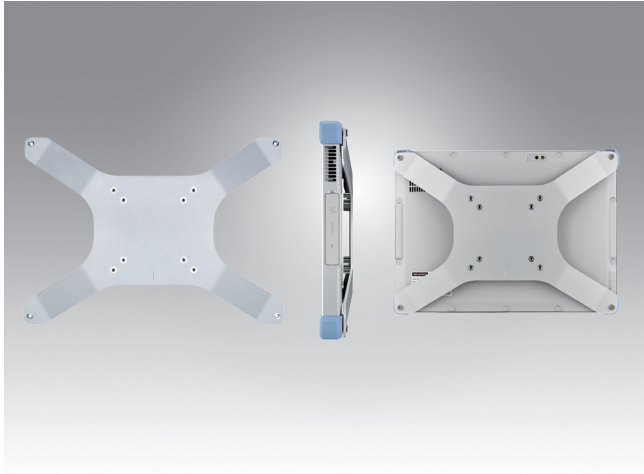

## Features

- Suitable design for VESA mounting applications
- Mounted on a nursing cart or other extended station for stabilizing use
- Installed on articulating arms or wall mounts
- VESA-compliant mounting solutions (VESA MIS D Standard 75/100)

## Specifications

		VESA Mount Bracket
Mechanical	Dimensions (W x D x H)	328 mm x 238 mm x 11 mm
	Weight	310g / 0.683 lb
Screws	Amount	4 pcs
	Dimensions	M4 -0.7P * 15mm
	Weight	1.8g / 0.004 lb

## Dimensions

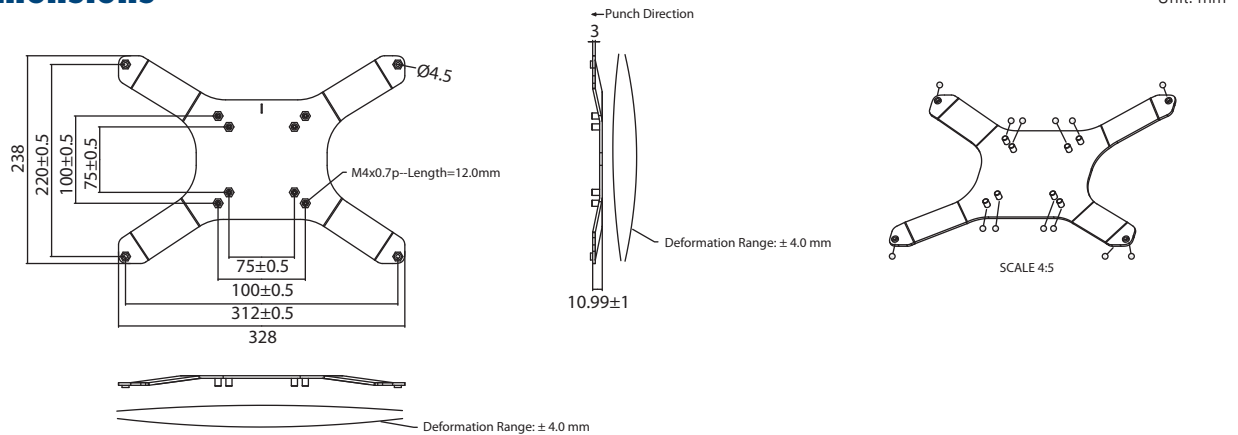

## Ordering Information

Part Number	Description
AIM-VSB0-0001	AIM-89H VESA Mount Bracket with 4 Screws

## Packing List

Description
1 x AIM-VSB0-0001
4 x Screws (M4 -0.7P * 15mm)

# AIM-89H Accessories

**Carry Strap**



**Shoulder Strap**



**Hand Strap**



Part Number	AIM-SRP0-0006	AIM-SRP0-0007	AIM-SRP0-0008
<b>Features</b>	<ul style="list-style-type: none"> <li>Straps with lanyard hook</li> <li>Enhance mobility</li> </ul>	<ul style="list-style-type: none"> <li>Straps with lanyard hook</li> <li>Enhance mobility</li> </ul>	<ul style="list-style-type: none"> <li>Hand Straps with 4 Screws</li> <li>Enhance mobility</li> </ul>
<b>Dimensions</b>	310 x 25 (mm)	1280 x 60 (mm)	338 x 235 (mm)
<b>Weight</b>	28g / 0.0617 lb	66g / 0.1455 lb	68 / 0.15 lb

# DeviceOn - iService Suite

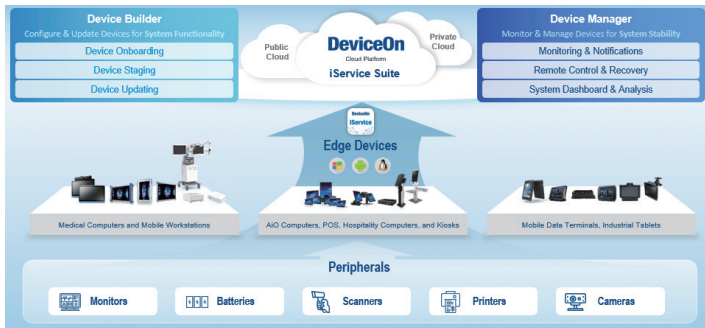

## Introduction

Advantech's DeviceOn - iService Suite is an advanced remote device management solution that enables you to centrally manage your devices, minimizing the need for expensive on-site visits and saving your valuable time and resources. Device Builder ensures that your devices are always up-to-date with the latest configuration and software updates, reducing the risk of data breaches and other security threats. Meanwhile, Device Manager helps to ensure that your devices are functioning correctly, reducing downtime and enhancing productivity.

## Key Functions

### Device Builder



#### Device Onboarding

- Support Windows, Linux, Android devices
- Quick enrollment process



#### Device Staging

- OS configuration
- Software/peripheral watchlist
- Device label, alarm rules



#### Device Updating

- Cloud software storage
- Installation package for multiple software updating

### Device Manager



#### Monitoring & Notifications

- Connection/hardware status
- Software/peripheral status
- Failure notifications

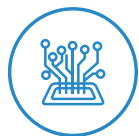

#### Remote Control & Recovery

- Reboot & power controls
- Audio & backlight settings
- Screenshots & remote desktop



#### System Dashboard

- Devices working status
- Software version sync status
- Results of scheduled tasks

## Services & Specifications

Functions List	OS Platform			Service Type	
	Windows	Android	Linux (Ubuntu)	Builder	Manager
	10, 11	8, 10, 12	TBD		
Device Onboarding - Enrollment, Locations and Labels	✓	✓		✓	✓
Profile - OS Settings (KIOSK Mode, ON/Off Schedule, others are OS dependent)	✓ (LTSC)	✓		✓	✓
Profile - Alarm Rules, Software Monitoring, Peripheral Monitoring	✓	✓			✓
OTA Update - Installation Packs, Software Cloud Storage	✓	✓		✓	✓
Monitoring - Device Hardware (CPU/RAM/Storage/Battery)	✓	✓			✓
Monitoring - Advanced Battery Management	✓ (Dependant on device model)				✓
Monitoring - Device Software (Running Status/CPU & Memory Usage)	✓	✓			✓
Monitoring - Peripherals & Display (Connect Status)	✓				✓
Control - Audio volume & Backlight	✓	✓			✓
Control - Screenshot, Reboot, Shutdown	✓	✓			✓
Control - Schedule Tasks	✓	✓			✓
Control - Remote Desktop	VNC				✓

## Ordering Information

Ordering P/N	Cloud Type	Description
36CSDOISSASP01	SaaS subscription	DeviceOn - iService Suite device annual fee (365 days)
36CSDOISPSRP01	On-premise server	DeviceOn - iService Suite device license (perpetual)
36CSDOISPSRP02	On-premise server	Software and installation fee for new server deployment
36CSDOISPSRP03	On-premise server	Annual maintenance fee after warranty